

Outline Dimensions

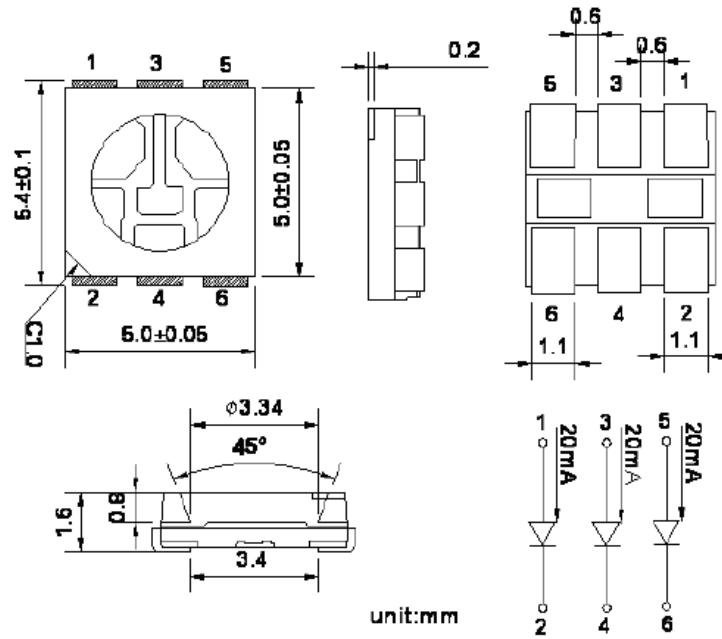

RECOMMEND PADLAYOUT

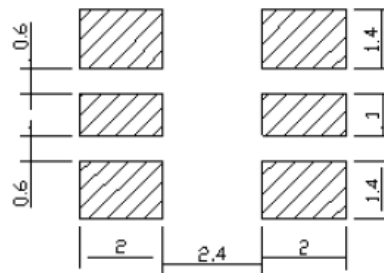

§ All dimensions are in millimeters.

§ Tolerance is ± 0.1 mm unless other specified

§ Specifications are subject to change without notice.

Fig.1 IF-VF(Ta=25°C)

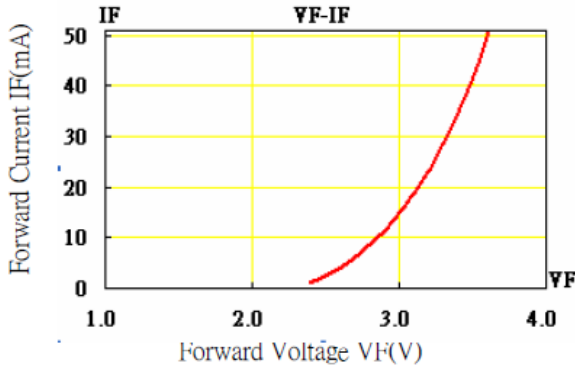

Fig.2 Relative Luminous Intensity-IF (Ta=25°C)

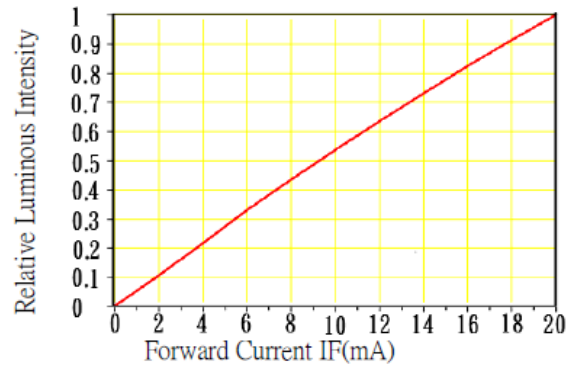

Fig.3 Wavelength Characteristics (Ta=25°C)

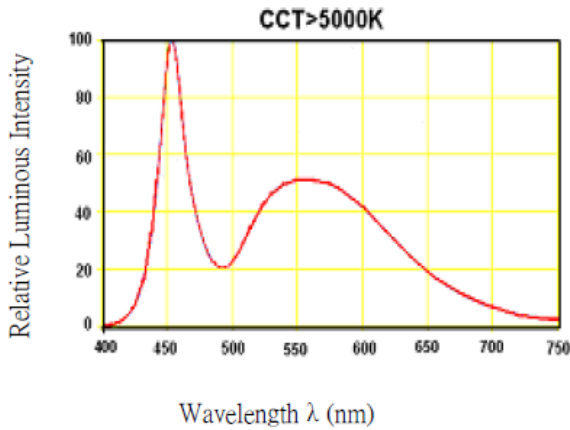

Fig.4 Relative Luminous Intensity-Ta

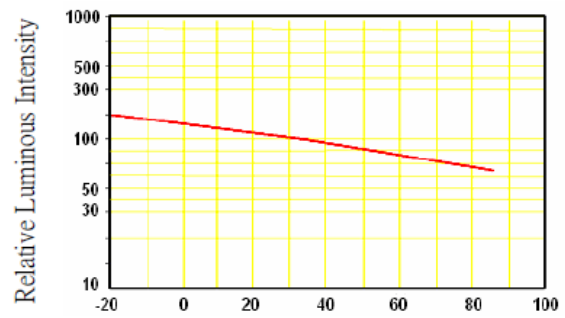
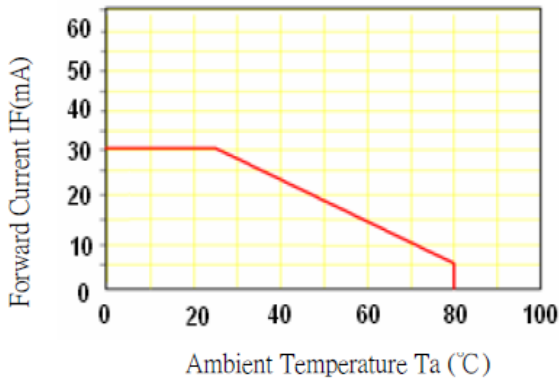
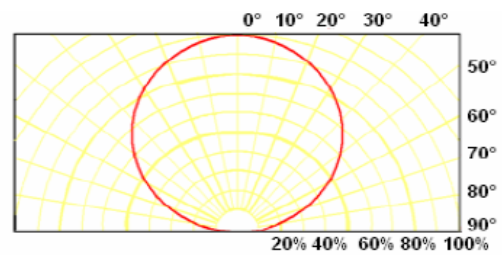

Fig.5 IF-Ta



Ambient Temperature Ta (°C)

Directive Characteristics (Ta=25°C)



Ver: 1.2

kwalitiy

KWALITY PHOTONICS PRIVATE LIMITED

ISO 9001-2008 29, EC Kushaiguda, Hyderabad-50 062, INDIA. PH:91-040-27123555,27136252 09246227946

Email: sales@kwalitiyindia.com www.kwalitiyindia.com