

Datasheet no. 65 5MM STRAW HAT LEDs KL5SH5W

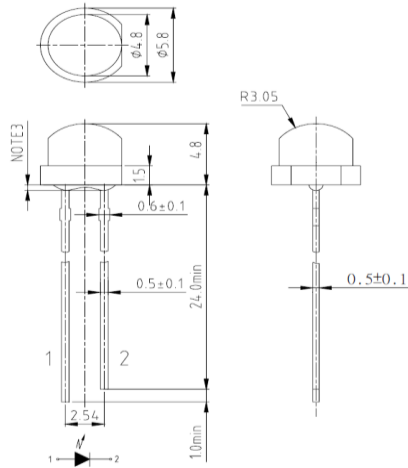

Electro-Optical Characteristics

Parameter	Symbol	VALUE			UNIT	Condition
		MIN	TYP	MAX		
Forward Voltage	Vf	2.8	3.3	3.8	V	If=20mA
Reverse Current	IR	--	---	10	µA	VR=5V
Luminous Intensity	Iv	1700	2100	---	mcd	If=20mA
Luminous Output	Lm	5	---	7	Lm	If = 20mA
Wave Length	X	---	0.301	---	---	If =20mA
	Y	---	0.301	10	µA	If = 20mA
Viewing angle	2 Ø	---	120	---	Deg	If = 20mA
	½					

Directive Characteristics (Ta=25°C)

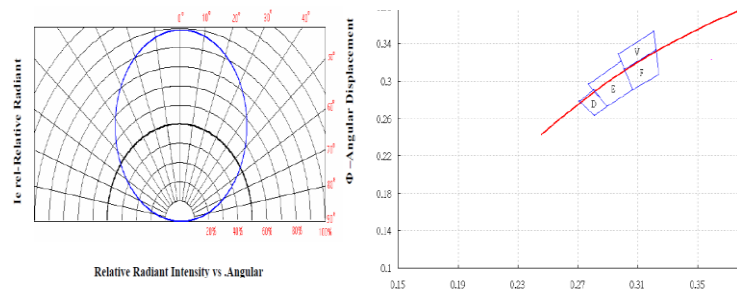

Electrical characteristic graph

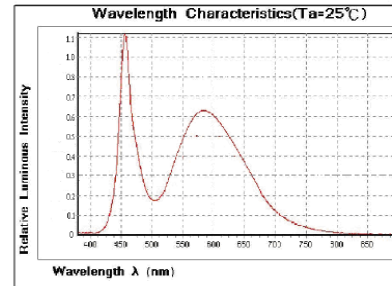
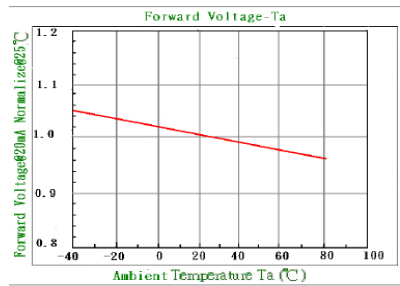
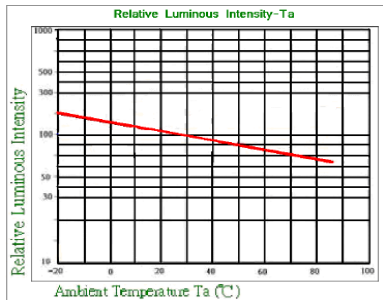
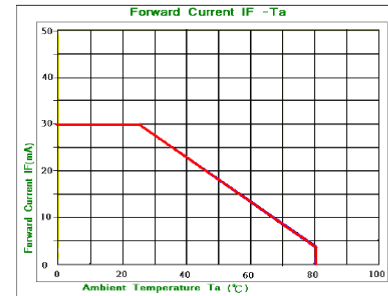
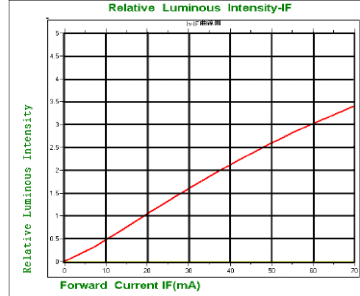
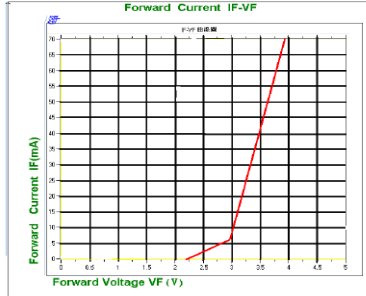

kwality

KWALITY PHOTONICS PRIVATE LIMITED

ISO 9001-2000

29, EC Kushaiguda, Hyderabad-50 062, INDIA. PH:91-040-27123555, 27136252 092462 27946

Email: sales@kwalityindia.com

www.kwalityindia.com

KPD/Straw Hat LEDs Specs /02

Dt.16.08.2010